

# iT0420 Ice Cube Machine

## Models

- IDT0420A     IYT0420A     IDT0420W     IYT0420W



Indigo NXT Series iT420 Ice Machine on D320 Bin

\*Ice Machine and Bin sold separately

Designed for operators who know that ice is critical to their business, the Indigo NXT Series ice machine's preventative diagnostics continually monitor itself for reliable ice production. Improvements in cleanability and programmability make your ice machine easy to own and less expensive to operate.

- **New levels of Performance** – Showcasing an average of 41% lower energy consumption, 21% reduction in in potable water usage and a 34% reduction in condenser water usage. This translates into lower cost of ownership over the life of your machine.
- **easyTouch® Display** - New icon based touch screen takes the guess work out of owning and operating an ice machine.
- **Programmable Ice Production** – Now its super easy to program your ice machine to be off at certain times of the day to save money with fluctuating electrical rates. Also programmable by daily ice production volume and night time programming.
- **Easy to Clean Foodzone** – Hinge front door swing out for easy access. Removable water-trough, distribution tube, curtain, water probe and water pump for fast and efficient cleaning. Selected components are made with AlphaSan® antimicrobial.
- **Intelligent Diagnostics** – Provides 24 hour preventative maintenance and diagnostic feedback for trouble free operation.
- **Acoustical Ice Sensing Probe** – Unique patented technology allows for reliable operation in challenging water conditions and environments
- **DuraTech® Exterior** – Provides superior corrosion resistant above stainless steel. Innovative clear-coat resists fingerprints and dirt making it easier to keep clean.
- Available **LuminIce® II Virus and Bacteria Inhibitor** – Controls viruses, bacteria, mold, and yeast within the food zone to keep the ice machine clean longer. A new sanitation icon lets you know the operational status.
- **Active Sense** – insures consistent ice harvest in all environmental conditions. This software works in conjunction with the acoustical ice sensing probe improving reliability and performance

## Ice Machine Electric

115/60/1 standard  
(208-230/60/1 also available)

### Minimum circuit ampacity:

Air-cooled: 11.3, 115v, 5.5 208-230v  
Water-cooled: 10.6, 115v, 5.2 -208-230v

### Maximum fuse size:

Air-cooled: 15 1ph  
Water-cooled: 15 1ph



## Specifications

**BTU Per Hour:**  
3,800 (average),  
and 6,000 (peak)

### Refrigerant:

R410A CFS - Free  
Lowers global warming  
by 48% 51.1 kPa)

### Operating Limits:

- Ambient Temperature Range:  
40 to 110 F (4.4 to 43.3 C)  
Water Temperature Range:  
40 to 90 F (4.4 to 32.2 C)
- Potable Water Pressure:  
Min. 20 psi (137.9 kPa)  
Max. 80 psi (551.1 kPa)
- Condenser Water Pressure:  
Min. 20 psi (137.9 kPa)  
Max. 276 psi (1902.95 kPa)

## Ice Shape



**Half Dice**  
3/8" x 1 1/8" x 7/8"  
(.95 x 2.86 x 2.22 cm)



**Dice**  
7/8" x 7/8" x 7/8"  
(2.22 x 2.22 x 2.22 cm)





### iT0420 on D-320 Storage Bin

- (A) Electrical Entrance (2) Options
- (B) 3/8" (0.95 cm) F.P.T. Water Condenser Inlet (water-cooled units)
- (C) 1/2" (1.27 cm) F.P.T. Water Condenser Outlet (water-cooled units)
- (D) 1/2" (1.27 cm) Auxillary Base Drain Socket
- (E) 3/8" (0.95 cm) F.P.T. Ice Making Water Inlet
- (F) 1/2" (1.27 cm) F.P.T. Ice Making Water Drain
- (G) 3/4" (1.91 cm) Bin Drain

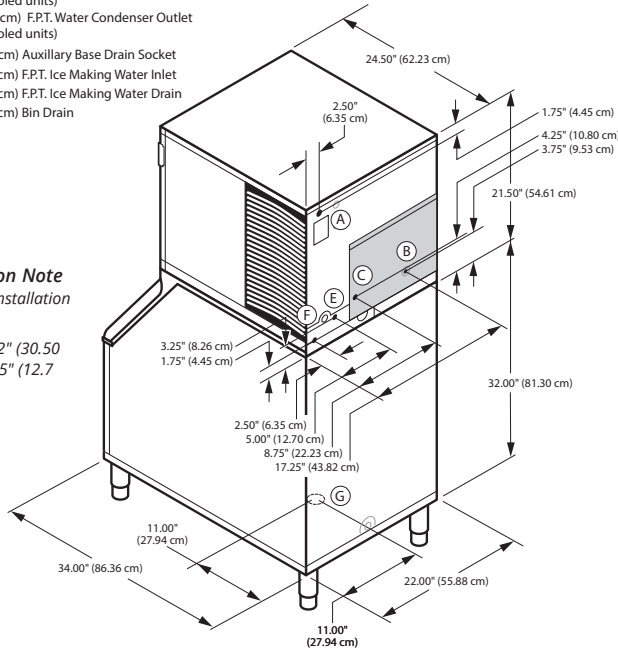

**Installation Note**  
Minimum installation clearance:  
Top/side: 12" (30.50 cm)  
Back is 5" (12.7 cm)

### Space-Saving Design



	iT0420 D-320	iT0420 D-420
Height	59.50" 151.13 cm	71.50" 181.61 cm
Width	22.00" 55.88 cm	22.00" 55.88 cm
Depth	34.00" 86.30 cm	34.00" 86.30 cm
Bin	264 lbs.	383 lbs.
Storage	118 kgs.	174 kgs.

Height includes adjustable bin legs 6.00" to 8.00", (15.24 to 20.32 cm) set at 6.00" (15.24 cm).  
Bin capacity is based on 90% of the volume x 33 lbs/ft<sup>3</sup> average density of ice.

### Specifications

	Model	Ice Shape	Ice Production 24 Hours		Power Usage kWh/100 lbs. @90°Air/70°F	Potable Water Usage/100 lbs. 45.4 kgs. of Ice
			70°Air/ 50°F Water	90°Air/ 70°F Water		
AIR COOLED	IDT0420A	dice	470 lbs.	375 lbs.	5.6 ★	19 Gal.
			213 kgs	170 kgs		72 L
	IYT0420A	half-dice	460 lbs.	375 lbs.	5.4 ★	19 Gal.
WATER COOLED	IDT0420W	dice	454 lbs.	400 lbs.	4.28	19 Gal.
			206 kgs	181 kgs		72 L
	IYT0420W	half-dice	490 lbs.	425 lbs.	4.24	19 Gal.
			222 kgs.	193 kgs		72 L

\* Water-cooled Condenser Water Usage / 100 lbs. /45.4 kgs. Of Ice: 140 gal/ 530 L.  
\*Water-cooled models are excluded from ENERGY STAR qualification.

Order separately: Ice storage bin for all units  
★ ENERGY STAR<sup>®</sup> 3.0 qualified

### Accessories

**LuminIce<sup>®</sup> II Virus and Bacteria Inhibitor**  
controls viruses and bacteria in the ice machine.



**External Scoop holder**  
protect the ice scoop with the NSF approved versatile scoop holder.



**Arctic Pure<sup>®</sup> Water Filters**  
reduces sediment and chlorine odors for better tasting ice.



**iAuCS<sup>®</sup>**  
schedules and performs routine ice machine cleaning automatically.



Welbilt reserves the right to make changes to the design or specifications without prior notice.